



Manual

Version
September 2023



BATTERY INTERFACE BOX (BIB)

12V 350A/600A | 24V 350A/600A | 48V 350A/600A



User Manual Battery Interface Box (BIB)

Dear customer,

This manual contains all the necessary information to install, use and maintain the Battery Interface Box. We kindly ask you to read this manual carefully before using the product. In this manual the Battery Interface Box will be referred to as the BIB. This manual is meant for the installer and the user of the BIB. Only qualified personnel may install and perform maintenance on the BIB. Please consult the index at the start of this manual to locate information relevant to you.

During the use of the product, user safety should always be ensured, so installers, users, service personnel and third parties can safely use the BIB.

Copyright© Super B All rights reserved. Licensed software products are owned by Super B or its subsidiaries or suppliers, and are protected by national copyright laws and international treaty provisions. Super B products are covered by Dutch and foreign patents, issued and pending. Information in this publication supersedes that in all previously published material. Specifications and price change privileges reserved. Super B is a registered trademark of Super B.

For more information please contact:

Super B Lithium Power B.V.
Europalaan 202
7559 SC Hengelo (Ov) The Netherlands
Tel: +31(0)88 00 76 000
E-mail: info@super-b.com
www: www.super-b.com

Table of content

1. Safety guidelines and measures	5
1.1. General	5
2. Introduction	5
2.1. Product description	5
2.2. Intended use	5
2.3. Glossary of Terminology	5
2.4. Used symbols	6
3. Product specifications	6
3.1. Product features	6
3.2. Real Time Clock (RTC)	7
3.3. BIB functional behaviour	7
3.3.1. General description	7
3.3.2. BIB states	7
3.4. BIB control functions	9
3.4.1. Auto-on	9
3.4.2. SoC shutdown	9
3.4.3. Reset button	9
3.5. Technical specifications	10
3.5.1. Electrical specifications	10
3.5.2. Mechanical specifications	10
3.5.3. Temperature specifications	11
3.5.4. Compliance specifications	11
3.6. Scope of delivery	11
3.7. Connections and indicators	12
3.7.1. CAN connector pinout (Master/Slave)	13
3.7.2. LED indicators	13
3.8. Peripheral equipment	14
4. Installation	15
4.1. General information	15
4.2. Unpacking	15
4.3. Required tools for installation	15
4.4. Preparing the BIB for use	15
4.4.1. Placement of the BIB	15
4.5. Connecting the power cables of the battery bank to the BIB	16
4.6. Wire sizes	18
4.6.1. Connecting the CAN network cables	18
4.6.2. CAN Bus network topology	19
4.6.3. Termination Resistors	19
4.6.4. Installation of the CAN power cable	19



4.6.5.	Coin Cell	20
4.7.	Disconnecting the BIB	21
5.	BIB use	21
5.1.	General information	21
5.2.	Configuring the battery bank and the BIB	21
5.2.1.	Battery ID's	21
5.2.2.	Battery ID renumbering procedure	22
5.2.3.	Battery layout	25
5.2.4.	Input level configuration	26
5.2.5.	BCI Modules	27
5.2.6.	General settings	27
5.3.	Power up the BIB	27
5.4.	Status and control of the BIB	28
5.5.	Status of the battery bank	29
6.	Inspection and cleaning	29
6.1.	General information	29
6.2.	Inspection	29
6.3.	Cleaning	29
6.4.	Replacing the Coin Cell Battery (For BCI HW V1.7 and above)	30
6.4.1.	Instructions for replacing the coin cell	30
7.	Storage	32
8.	Troubleshooting	32
9.	Warranty and liability	33

1. Safety guidelines and measures

1.1. General

- Treat the BIB as described in this manual.
- Observe the markings on the BIB and ensure correct use.
- Do not disassemble, crush, puncture or shred the BIB.
- Do not expose the BIB to heat or fire.
- Do not remove the BIB from its original packaging until required for use.
- Do not mix Li-ion batteries of different capacity, size or type. Only use Super-B Li-ion traction batteries with the BIB.
- Retain the original product documentation for future reference.

⚠ Warning! Always take safety precautions when working on battery systems.

2. Introduction

2.1. Product description

The Battery Interface Box (BIB) is a device capable to connect and disconnect a battery or a battery bank to a load / charger (DC bus) with the intent to protect the Li-ion battery or battery bank against improper use. The BIB communicates with the battery's BMS (Battery management system) to request to the batteries if they are operable and used within their limits.

2.2. Intended use

The Battery Interface Box (BIB) is intended to use as a disconnect device for protecting batteries against misuse. Potential applications of the BIB include: off grid power supply, marine power supply, industrial power supply and (renewable) energy storage. The BIB may not be used in medical and aviation related applications.

2.3. Glossary of Terminology

BMS	Battery Management System
BIB	Battery Interface Box
BCI	Battery Communication Interface
LiFeP04	Lithium Iron Phosphate
Battery monitor	PC application for monitoring control and configuration
DC-bus	Load charger side of the BIB
SoC	State of charge

Table 1. Glossary of Terminology

2.4. Used symbols

The following icons will be used throughout the manual:

- ⚠ **Warning!** A warning indicates severe damage to the user and/or product may occur when a procedure is not carried out as described.
- ⚠ **Caution!** A caution sign indicates problems may occur if a procedure is not carried out as described. It may also serve as a reminder to the user.

3. Product specifications

3.1. Product features

The BIB ensures the following functions:

- Collecting the status and alarm messages of all the Li-ion batteries connected. In case of an alarm in one of the batteries, the BIB will disconnect the battery (bank) by opening the main relay.
- Scanning the CAN bus to see if all the batteries it expects are present. In case of a missing battery, the BIB will disconnect the battery (bank) by opening the main relay.
- Collecting information of all Li-ion batteries in the battery bank and presenting it as one battery.
- Programmable power down on user adjustable battery (bank) SoC level.
- Programmable Auto-On function.
- Up to sixteen batteries can be connected to the BIB without external CAN power. (With the 12V BIB versions, external CAN power is always necessary.)
- Up to 100 Li-ion batteries can be connected to the BIB with use of external CAN power.
- Pre-charge as startup sequence to prevent inrush currents.
- Real time clock for accurate time stamped function, statistics and error logging.
- The BIB is a standalone device.
- The BIB can be configured using a CAN-USB converter and the battery monitor software.

The BIB mainly includes the following:

- A main relay to connect or disconnect the Li-ion batteries from the DC bus.
- A pre-charge circuit including a relay , a resistor, and a thermostat for protection.
- Two CAN communication ports:
- The master port indicated by J1. This port is for the Li-ion batteries. The communication protocol used is CANOpen.
- The slave port indicated by J2. This port is to communicate with an external network. This port can also be used for other CAN protocols.

All the battery (bank) values can be monitored on both ports. The battery bank can also be

controlled via both ports. If the slave port (J2) is used for another protocol than CANOpen, monitoring and control of the battery bank using the battery monitor software can only be done on the master port (J1).

- Three status LED's to indicate the status of the battery (bank).

3.2. Real Time Clock (RTC)

Compatible BCIs (Hardware version V1.7 and above) are delivered fitted with an CR1216 coin cell, which is used to power the internal RTC (Real time clock). This provides several additional functions for when external/battery bank power is lost or not present:

- Accurate time-stamped error logs (available in software version \geq V2.40)

3.3. BIB functional behaviour

3.3.1. General description

The BIB monitors all connected Li-ion batteries through the CAN bus. Whenever one or more Li-ion batteries reports an alarm, or is missing on the bus, the BIB will disconnect the battery (bank) from the DC bus to avoid misuse of the battery or to prevent an unsafe situation. The alarms from the battery can differ with each battery type. Because the alarm is indicated to the BIB as a general alarm, any Super-B battery with CANOpen communication can be used in combination with the BIB. For alarms detected and signalled by the battery consult the manual of the battery.

3.3.2. BIB states

The BIB different states, are listed in table 2 below.

State	Main relay	Pre-charge relay	Description
ON	On	Off	Bank is connected to the DC-bus
OFF	Off	Off	Bank is disconnected from the DC-bus
Pre-charge	Off	On	Bank is pre-charging the DC-bus
Error	Off	Off	An error occurred, see below
Shutdown	Off	Off	BIB is in power down mode, see below
Undervoltage reboot	On	Off	BIB is turned on again after an undervoltage shutdown

Table 2. BIB States

3.2.2.1 ON state

The BIB is in or can be set to the ON state when there are no active errors. In this state the

main relay is enabled, the battery bank is connected to the DC bus. The BIB can be set to ON state using the battery monitor, or automatically when the auto-on feature is enabled. The BIB can only reach the ON state via the pre-charge state first.

3.2.2.2 OFF state

The BIB can be set in OFF state by the battery monitor software. In this state the main relay is disabled, the battery bank is disconnected from the DC bus.

3.2.2.3 Pre-charge state

A battery bank system with a large capacitive load can be exposed to high electric current during initial turn-on. This current, if not limited, can cause considerable stress or damage to the system components. Pre-charging is implemented to increase the lifespan of electronic components and increase reliability of the battery bank. In the pre-charge state the main relay is disabled and the pre-charge relay is enabled. The main relay will only be enabled when the voltage across the main relay is less than 1.25V times the number of batteries in series. For example, for an 48V system (four batteries in series) the voltage across the relay should be less than 5V. The BIB will go into the ON state 1 seconds after the main relay has been enabled. Table 3 shows the ohmic value of the pre-charge circuit.

- ⚠ **Caution!** If the system draws more current than the pre-charge current the BIB will not be able to engage the main relay since it cannot properly pre-charge the system.
- ⚠ **Caution!** It is important that the load is not engaged before the BIB is done pre-charging.

3.2.2.4 Error state

When the BIB is in error the following may have occurred:

The number of batteries that respond to a present request does not match the number of batteries configured in the BIB. If the error is resolved the BIB goes to OFF state or when auto on is enabled to ON state.

One or more of the batteries reports an alarm. When the alarm of the battery is cleared the BIB goes to OFF state or ON if the auto on feature is enabled. Depending on which type of alarm the battery signalled, this alarm can be cleared automatically. Refer to the battery manual for the type of alarm and how to resolve it.

3.2.2.5 Shutdown state

In this state the main relay and the pre-charge relay are disabled, the BIB doesn't take any power from the battery bank and will turn off. However, if there is power on the DC bus the BIB will stay on and takes only power from the DC-bus.

3.2.2.6 Undervoltage shutdown

When a battery indicates an undervoltage, the BIB will go into the shutdown state. The BIB

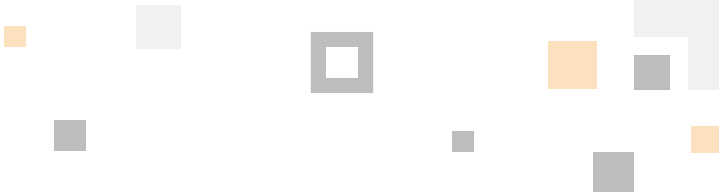

can be turned on again by using the on/off button. When this happens, the BIB will go into the undervoltage reboot state.

3.2.2.7 Undervoltage reboot state

In the undervoltage reboot state the battery (bank) will be connected to the DC-bus but discharging is limited regarding capacity to 0.1 Ah.

This allows chargers that need to see a battery, to start charging. The BIB will now allow the battery bank to be discharged with 0.1Ah before it will go to shutdown state again. When the battery bank is charged with 1Ah the BIB will switch to the ON state. The BIB will also go to the shutdown state after 10 minutes spend in the undervoltage reboot state, this implies that the battery bank should be charged with at least 1Ah to avoid unnecessary shutdown

3.4. BIB control functions

3.4.1. Auto-on

The auto-on function automatically sets the BIB into ON state when the BIB is powered up. Also if a battery alarm has occurred and this alarm is cleared (see 3.2.2.4) the BIB automatically goes to the ON state if the auto-on function is enabled. The battery monitor software can be used to control the auto-on function.

3.4.2. SoC shutdown

The SoC shutdown is a function that makes it possible to put the BIB in shutdown state at a certain level of state of charge. The level can be set by the user and this function can be enable or disabled. By default, it is disabled. Control of this function is done by the battery monitor software.

When the battery bank reaches the SOC shutdown level, the BIB will go into shutdown state. The shutdown is activated only with descending SoC level. If the BIB is in shutdown state it can be turned on again by using the on/off button. When the BIB is turned on again, it will not shutdown on SOC again unless the SoC of the battery (bank) is charged 1% above the shutdown level. This re-enables this functionality. Once the SoC shutdown has occurred and the BIB is turned on again and no charge is applied, the battery bank can be discharged until an undervoltage shutdown occurs.

3.4.3. Reset button

Some alarm types of the battery can only be cleared by a reset. To perform a reset, press the reset button on the BIB or use the battery monitor.

3.5. Technical specifications

3.5.1. Electrical specifications

The BIB is available in various variants. The BIB is available in two current ranges and in three voltage ranges. Table 3 shows the technical specifications of the variants:

	SB BIB LV12V350A V2	SB BIB LV24V350A V2	SB BIB LV48V350A V2	SB BIB LV12V600A V2	SB BIB LV24V600A V2	SB BIB LV48V600A V2
Supply Voltage	7.5V - 16V	7.5V - 32V	15V - 64V	7.5V - 16V	7.5V - 32V	15V - 64V
Rated Current	350A	350A	350A	600A	600A	600A
Precharge Resistor Value	1 ohm	4 ohm	16 ohm	1 ohm	4 ohm	16 ohm
Voltage difference across main relay to turn-on	1.25V	2.5V	5V	1.25V	2.5V	5V
Consumption in OFF-state	100mA	100mA	100mA	100mA	100mA	100mA
Approximate consumption on standby	330mA	197mA	142mA	740mA	420mA	260mA

Table 3. Electrical specifications

3.5.2. Mechanical specifications

	SB BIB LV12V350A V2	SB BIB LV24V350A V2	SB BIB LV48V350A V2	SB BIB LV12V600A V2	SB BIB LV24V600A V2	SB BIB LV48V600A V2
Dimensions (LxWxH)	180 x 254 x 111 mm / 7.08" x 10" x 4.37"					
Case material	PC					
Weight	2.0 kg (±100g)	2.0 kg (±100g)	2.0 kg (±100g)	2.4 kg (±100g)	2.4 kg (±100g)	2.4 kg (±100g)

Ingress protection

IP54¹

Table 4. Mechanical specifications

¹For proper installation read chapter 4

3.5.3. Temperature specifications

Recommended operating temperature	-20°C to 45°C / -4°F to 113°F
Recommended storage temperature range	-10°C to 20°C / 14°F to 68°F
Relative humidity	10-90%

Table 5. Temperature specifications

3.5.4. Compliance specifications

Certifications

CE

Table 6. Compliance specifications

⚠ Warning! The BIB may only be used in conditions specified in this manual. Exposing the BIB to conditions outside the specified boundaries may lead to serious damage to the product and/or the user.

3.6. Scope of delivery

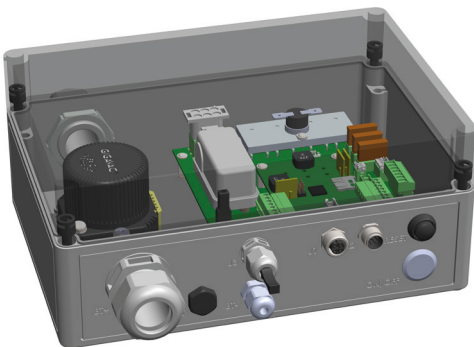

Figure 1. Scope of delivery.

1. (1x) Battery Interface Box
2. (1x) Male to male CAN cable 0.6m
3. (1x) CAN power cable (only with 12V BIB)
4. (1x) Label: BIB Schematic
5. (1x) CAN slave connector cover

3.7. Connections and indicators

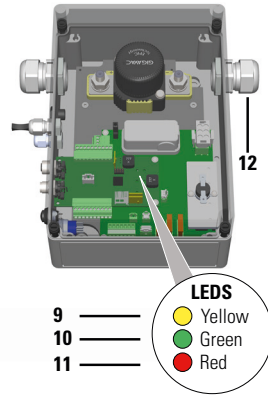
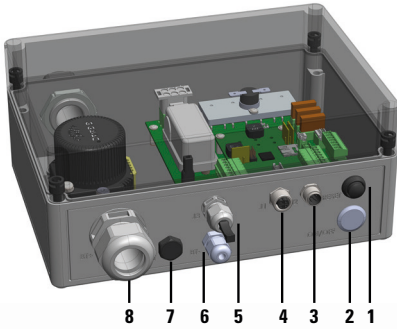

Figure 2. Connections and LED indicators

1. Reset button
2. On/Off button
3. CAN Slave connector (J2)
4. CAN Master connector (J1)
5. Cable gland for optional external connections (external reset button or LEDs) (J3)
6. Cable gland for Battery Terminal – (BT -)
7. Pressure compensating vent
8. Cable gland for Battery Terminal + (BT +)
9. LED 1 Indicator (Yellow)
10. LED 2 Indicator (Green)
11. LED 3 Indicator (Red)
12. Cable gland for Load +

3.7.1. CAN connector pinout (Master/Slave)

PIN #	Signal	Master side	Slave side
1	CAN_SHLD	Optional CAN Shield	Optional CAN Shield
2	CAN_V+	CAN bus supply voltage 12V	Not connected
3	CAN_GND	Ground / OV	Ground / OV
4	CAN_H	CAN_H bus line (dominant high)	CAN_H bus line (dominant high)
5	CAN_L	CAN_L bus line (dominant low)	CAN_L bus line (dominant low)

Table 7. CAN connector pinout

Male

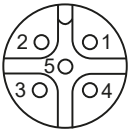

Female

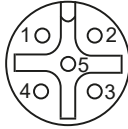

Figure 3. CAN Connections Male and Female

3.7.2. LED indicators

	LED 1 (Yellow)	LED 2 (Green)	LED 3 (Red)	Mode
1	Flashing	Off	Off	Precharge
2	Off	On	Off	Main relay On
3	On	On	Off	Main relay Off
4	On	On	On	Battery in error mode or communication error (communication error has the red LED 3 Flashing).
5	Off	Flashing	Off	CAN network scanning

Table 8. LED indicators

3.8. Peripheral equipment

The BIB can be used in combination with several Super B products

Product name	EAN code
Nomia 12V100Ah	8718531360662
Nomia 12V160Ah	8718531360570
Nomia 12V210Ah	8718531361645
Nomada 12V105Ah	8718531361799
CAN Terminator Resistor Female	8718531360808
CAN Terminator Resistor Male	8718531360815
CAN cable 0.6m	8718531360716
CAN cable 1m	8718531360723
CAN cable 2m	8718531360730
CAN cable 5m	8718531360747
CAN cable 10m	8718531360754
CAN T-Splitter Male to Male + Female	8718531360761
Be in Charge Monitoring Kit	8718531362086
CAN power cable	8718531360792
Touch display ¹	8718531361447
CAN Cable 0.6m Female right angled to Male straight	8718531361492

Table 9. Optional components that can be used with the BIB

¹ The touch display can only be connected to the CAN slave port of the BIB.

⚠ Caution! make sure the maximum supply voltage of the touch display will not be exceeded (see manual touch display), contact the Super B support department for more information.

4. Installation

4.1. General information

⚠ **Warning!** Never install or use a damaged BIB.

⚠ **Caution!** Do not reverse connect the BIB (polarity).

⚠ **Caution!** The BIB should not be used in mass switched systems. If the BIB is used in such a system please contact Super B to verify correct installation.

⚠ **Caution!** Use the BIB within the published specifications.

⚠ **Caution!** In case of an undervoltage shutdown, charge the Li-ion batteries immediately.

4.2. Unpacking

Check the BIB for damage after unpacking. If the BIB is damaged, contact your reseller or Super B. Do not install or use the BIB if it is damaged!

4.3. Required tools for installation

- Torque wrench
- Screwdriver flat 5 mm
- Screwdriver flat 2.5 mm
- 350A type: 17 mm (socket) wrench
- 600A type: 19 mm (socket) wrench

4.4. Preparing the BIB for use

4.4.1. Placement of the BIB

Before it is used, the BIB must be positioned in such a way that it will not move during use. The BIB may be fixed in place by using the mounting holes (Figure 4).

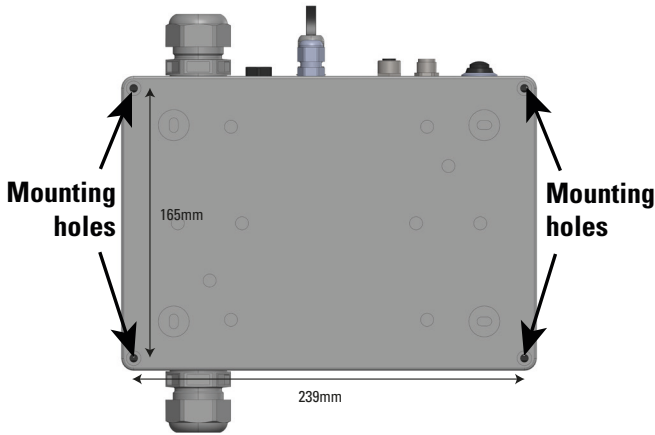

Figure 4. Installing the BIB by using the mounting holes

4.5. Connecting the power cables of the battery bank to the BIB

- ⚠ **Warning!** Follow the listed steps to avoid making a short circuit.
- ⚠ **Warning!** Make sure that the + power cable is not connected to the battery bank while installing the BIB.
- ⚠ **Caution!** Make sure that the BIB is off while installing (On/off button not pressed)

Use the following steps to connect the BIB with the battery bank (Figure 5 + 6)

1. Unscrew the protection cover
2. Connect the BT- terminal of the BIB to the (-) terminal of the battery bank.
3. Connect the (+) terminal of the load to the relay terminal at the LOAD + side, mount the internal ring terminal (see TODO) direct on the lug of the power cable.
4. Connect the (+) terminal of the battery bank to the relay terminal at the BT+ side, mount the internal ring terminal (see TODO) direct on the lug of the power cable.
5. Ensure both contacts are tightened to 20 Nm.
6. Secure the protection cover.

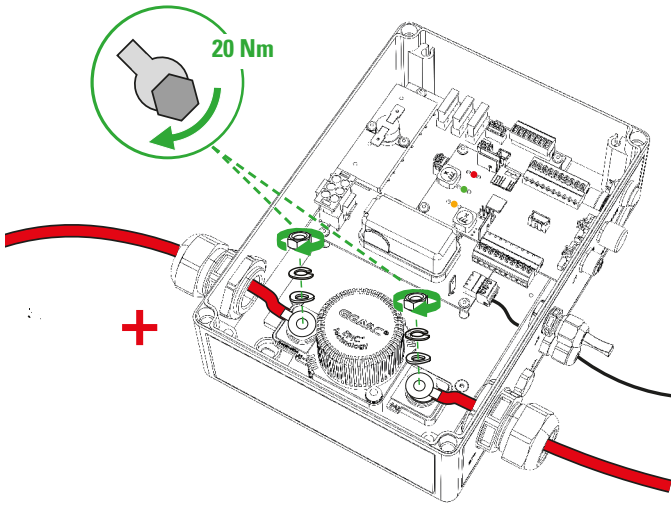

Figure 5. Connecting the BT+ and BT- terminal cables.

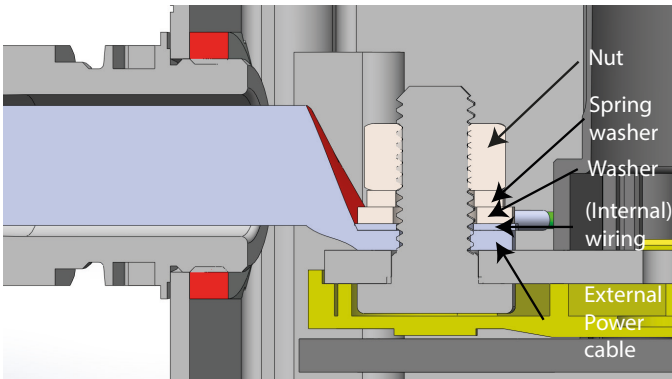

Figure 6. Connecting the power cables of the Li-ion battery to the BIB.

⚠ Caution! The BT- terminal cable should be connected to the minus of the battery bank.

4.6. Wire sizes

- ⚠ **Caution!** Use appropriate wire for the connection to ensure no overheating or unnecessary losses occur.
- ⚠ **Caution!** To ensure IP54, make sure to use the right wire size

Connection	Wire diameter min-max
BT+	13 - 21 mm
Load +	13 - 21 mm
BT-	2 - 5 mm
J3	3 - 7 mm

Table 10. Connecting wires

4.6.1. Connecting the CAN network cables

- ⚠ **Caution!** To ensure IP54, make sure the J2 connection remains covered by the cover when it is not used.

The Li-ion batteries should be connected to the BIB via the CAN interface. Start creating the CAN bus connection as shown in figure 7.

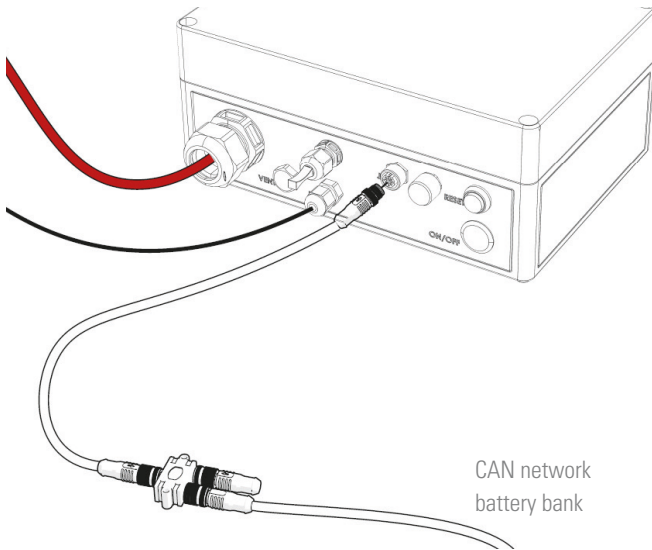

Figure 7. Connecting the CAN network cables.

The BIB must be connected to the male to male cable to the first splitter and from there the rest of the battery bank can be connected. For further information about the CAN network, read the manual of the batteries that will be connected to the BIB.

4.6.2. CAN Bus network topology

The CAN Bus must be used in a bus network topology. Do not use a ring- or star topology. The maximum CAN bus length is limited by the bitrate. The Li-ion battery has a default bitrate of 250kbps (See table 11).

Bit rate	Bus length (L)	Max. stub length (S)	Accumulated stub length
250 kbps	250 m	11 m	55 m

Table 11. CAN bus speed

4.6.3. Termination Resistors

The CAN bus requires termination at the two outer ends of the bus. It is advised to use the termination resistors (see paragraph 3.7) at the end nodes to prevent reflections on the line. The value of this resistor should be 120 ohm.

4.6.4. Installation of the CAN power cable

A 12V system always needs a CAN power cable. In a 24V or 48V system up to sixteen batteries the BIB provides power for the CAN bus. In any 24V or 48V system with more than sixteen batteries the CAN bus must be powered externally, using a CAN power cable. The CAN bus power should be at least 10V and should not exceed 30V! Therefore, in any 12V or 24V system the CAN bus can be powered directly by the system power.

⚠ Warning! When using a 48V system with more than sixteen batteries, please contact Super-b to discuss the installation of the system.

There are two possible ways to connect the CAN power cable to the BIB and Li-ion batteries:

1. The first option is to connect the (+) terminal (red wire) of the CAN power cable to the load side of the main relay. There is a disadvantage to this setup; when the main relay opens the CAN power is cut-off. This causes the loss of CAN communication between the batteries and the BIB. The load side of the BIB must be powered to have CAN communication while the main relay is OFF. Without CAN communication the BIB cannot turn on.

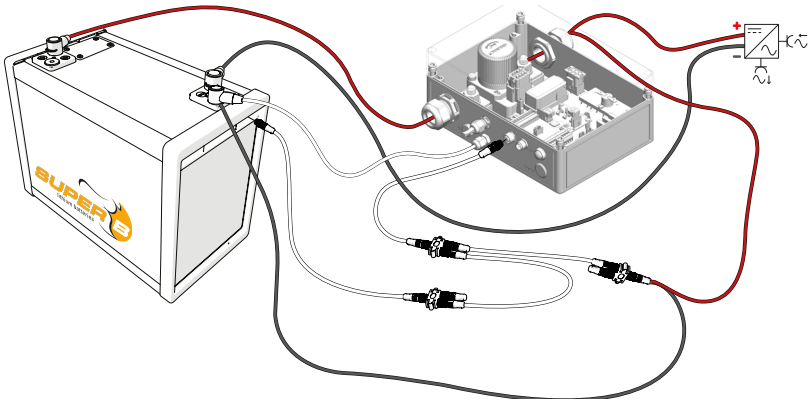

Figure 8. Connecting the CAN power cable to the load side of the main relay.

- The second option is to connect the (+) terminal of the CAN power cable to the batteries side of the main relay. In this case the CAN communication is always available. There is a disadvantage to this setup; the CAN bus is always powered, therefore; it will drain the Li-ion batteries slightly even when the main relay is turned off. When using this setup, Li-ion batteries can be deeply discharged.

Make sure that the Li-ion batteries will be charged immediately when they are empty.

4.6.5. Coin Cell

Compatible BCIs fitted inside the BIB (Hardware version V1.7 and above) are delivered with an CR1216 coin cell, which is used to power the internal RTC (Real time clock). After installing into an application, remove the coin cell insulator tab to power the RTC.

- ⚠ Caution!** Care should be taken when removing this tab, as in some cases, the coin cell can be pulled out of the retainer on removal of the isolator tab.

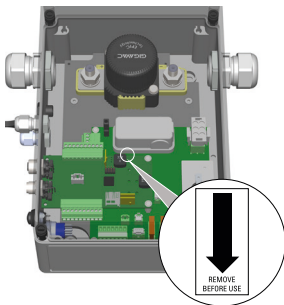

Figure 9. Location of the Coin Cell tab.

4.7. Disconnecting the BIB

The following steps must be taken to disconnect the BIB.

1. Turn off the BIB using the ON/OFF push button.
2. Disconnect the + power cable from the battery bank.
3. Disconnect the Load + from the BIB.
4. Disconnect the positive (+) wire from the BT+ terminal of the BIB.
5. Disconnect the BT- wire from the (-) terminal of the battery bank.
6. Disconnect the CAN cables from the BIB.

5. BIB use

5.1. General information

- ⚠ **Caution!** In case of an undervoltage shutdown, charge immediately.
- ⚠ **Warning!** Follow the safety guidelines and measures of chapter 1.

If a preconfigured system has been ordered at Super B, the steps in chapter 5.2 are not necessary. If this is not the case, configuring can be done as described in chapter 5.2.

5.2. Configuring the battery bank and the BIB

Before the BIB and battery bank can be used, the BIB needs to be configured and the batteries need to have a unique battery node ID. Configuring the BIB and the batteries can be done by using the Be in Charge Software. Please note that in the Be in Charge Software, the BIB is shown as BCI. This is due to the fact that the BCI is an important part of the BIB.

For connecting a computer to the BIB, the Be in Charge Monitoring Kit is required (see table 9).

5.2.1. Battery ID's

In multi-battery systems, each Li-ion battery must have a unique node ID (identifier). The default node ID for a Super B Li-ion battery is 10.

Any node ID between 2 and 127 can be assigned to a Li-ion battery. Node ID 1 cannot be used for a Li-ion battery as it is the node ID of the BIB. It is not recommended to use node ID 10 for multi battery configurations as it may be confusing in case a new Li-ion battery is added to the system.

Multiple Li-ion batteries with the same number will result in unpredictable behaviour of the battery bank. It is recommended labelling the batteries with their assigned node ID. Try to number the Li-ion batteries in such a way that the battery bank configuration can be

easily recognized. For example, in a 2 series 2 parallel system use node ID 11,12 for the two batteries in series and node ID 21,22 for the other two batteries in series.

5.2.2. Battery ID renumbering procedure

Use the following procedure to renumber the node ID for each battery in the system.

1. Connect one Li-ion battery to the BIB via the CAN connection (see figure 9).

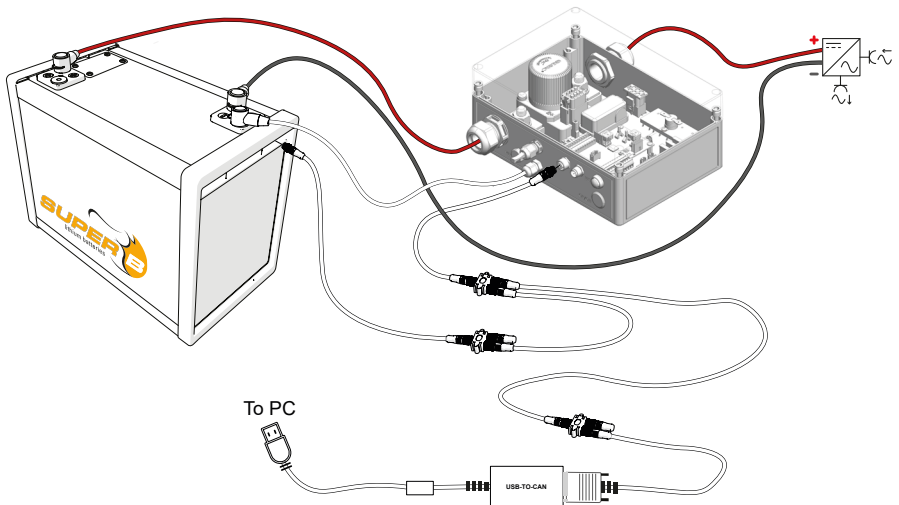

Figure 10. Setup for configuration using the Be in Charge Monitoring Kit

2. Select the 'Scan' button to start scanning for devices. You can also select the scan/refresh icon in the top-left corner (Figure 10).

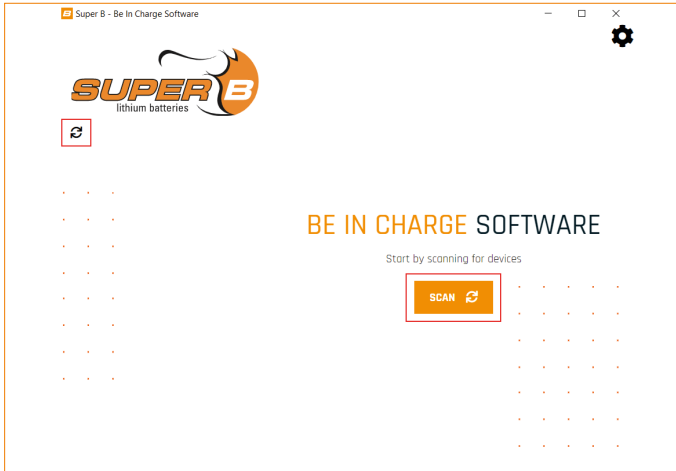

Figure 11. 'Scan' for devices

3. In order to make changes to battery node ID it is necessary to set the user level to 'Expert User' or 'Integrator' (Figure 17 and 18).

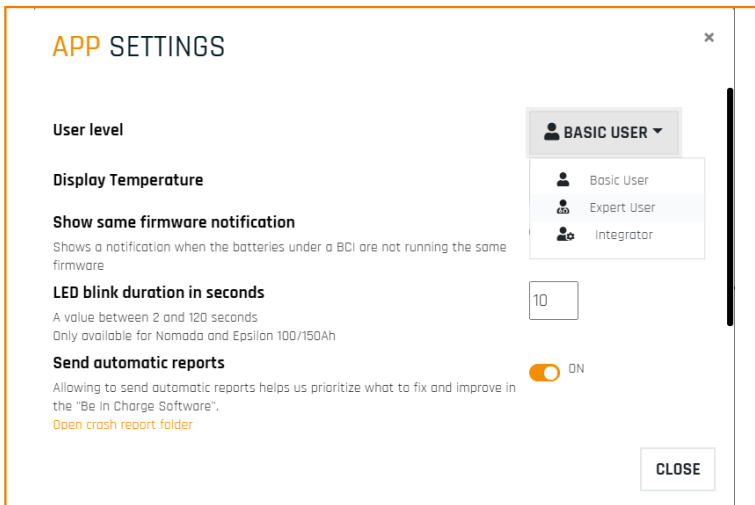

Figure 12. Set user level to 'Expert user'

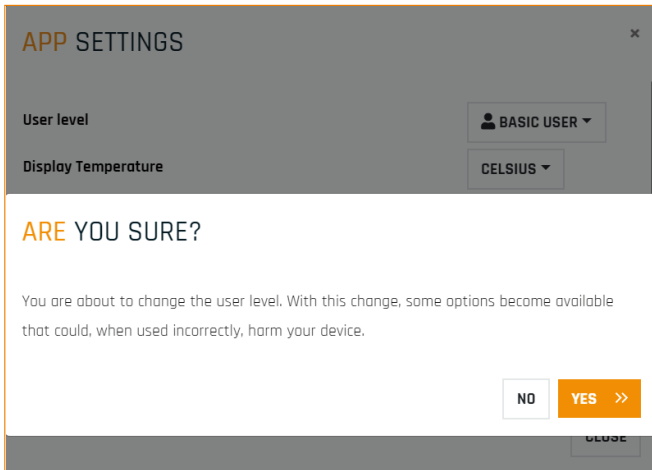

Figure 13. Confirm user level change

4. Navigate to the 'Details' page and make sure to change the battery node ID of the first battery to 11 (Figure 13 and 14)

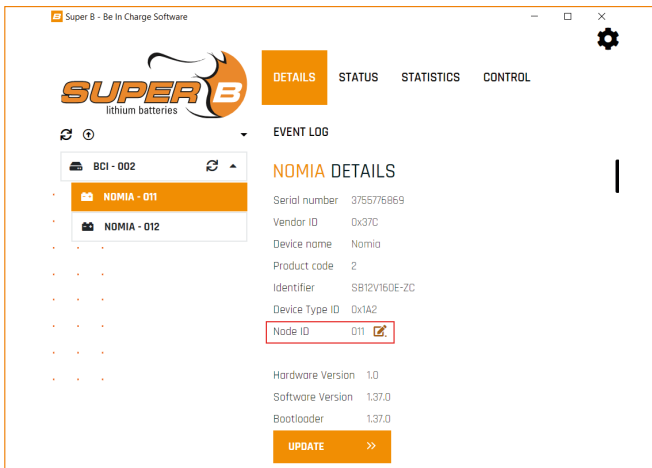

Figure 14. Change the battery 'Node ID' of the first Li-ion battery

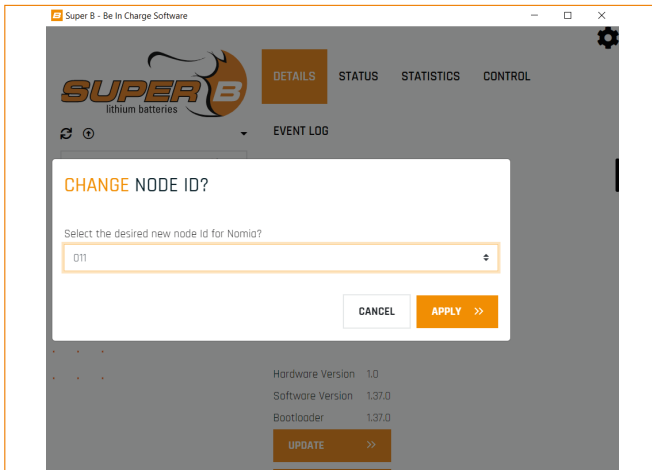

Figure 15. Select the desired new node ID from the dropdown menu

5. Verify if the correct number is assigned to the Li-ion battery by selecting the scan/refresh icon on the top-left corner.
6. Connect the next Li-ion battery and repeat step 4 and 5 until all Li-ion batteries have been assigned a unique Node ID.
7. Continue with the battery layout

5.2.3. Battery layout

The BIB represents a battery bank as one battery. To be able to do so, the BIB must be informed about the layout of the batteries. This means how the batteries are connected with regard to series and or parallel. The number of batteries that are connected is detected by the BIB itself by doing a full scan. If the BIB is not configured by Super B the end user must do this. Follow the procedure below to set the battery layout.

1. Connect all Li-ion batteries to the BIB via the CAN connection as described in chapter 4.6.1..
2. Click 'Scan'. Make sure to select the full Node-id range by dragging the selection bars. The Be in Charge Software requests the BIB to scan for connected Li-ion batteries. When the scan is completed, the BIB and all Li-ion batteries connected to it will be shown (see figure 15). Select "BCI", the number of Li-ion batteries connected will be shown in the "BCI Configuration" section in the "Total # batteries" field (see Figure 16).
3. Configure the battery bank with the sliders in the "#Batteries in series" and "#Batteries parallel" fields, or type in the correct values directly. The amount of Li-ion batteries in series multiplied by the amount of Li-ion batteries in parallel should be equal to the total amount of Li-ion batteries. The Be in Charge

software will not allow an invalid configuration.

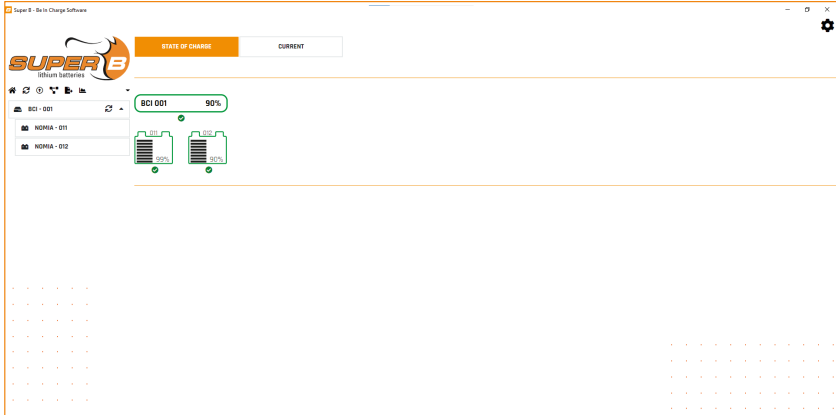

Figure 16. State of charge tab - BIB and Li-ion batteries

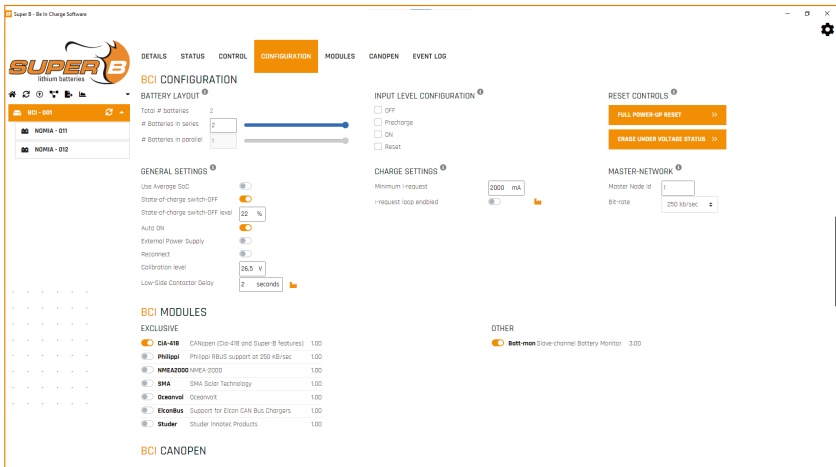

Figure 17. BCI Configuration

5.2.4. Input level configuration

The BIB contains four hardware inputs: OFF, Precharge, ON and Reset (see Figure 16; this option is only visible if the user level of the Be in Charge Software is set to 'Integrator', see

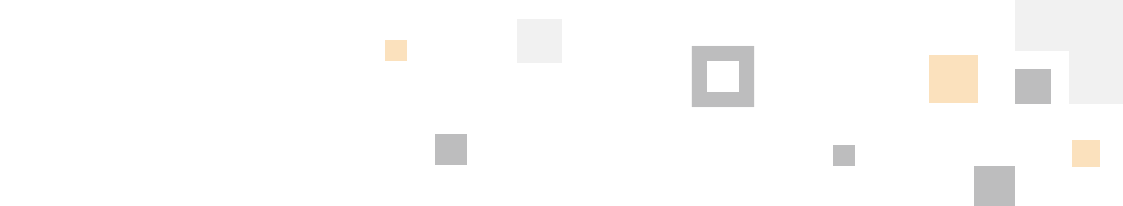

Figure 11). The inputs can be used to control the BIB. They can be set to active high or active low.

Note: this option is only visible if the user level is set to 'Integrator' (see Figure 11)

5.2.5. BCI Modules

The "BCI Modules" section (see Figure 16) can be used to select a communication protocol for the slave connector of the BIB (J2). The default setting is CANOpen (CiA418 and Super B features). There is also an option to use proprietary protocols. This list is subject to change therefore, the list may look differently depending on the software version.

Note: this option is only visible if the user level is set to 'Integrator' (see Figure 11)

5.2.6. General settings

5.2.6.1 Auto On

The 'Auto On' setting (see Figure 16) enables the automatic start up option function. If it is enabled the BIB will go to ON state (see 3.2.2.1) automatically when the BIB starts up or after a reset. The BIB will go to error state (see 3.2.2.4) if an error occurs. When the error is cleared the BIB will automatically go to ON state if the 'Auto On' function is enabled.

5.2.6.2 State-of-charge switch-OFF level

The State of charge switch off level is a function that makes it possible to put the BIB in shutdown state (see 3.2.2.5) at a certain level of state of charge. This level can be set by the user. This function can be enabled or disabled by the user. Default this function is disabled.

5.3. Power up the BIB

The BIB is powered up by pressing the ON/OFF button. If the auto on function is enabled and there are no active errors the BIB will go to ON state. If the auto on feature is disabled, it can be turned on manually (see chapter 5.4).

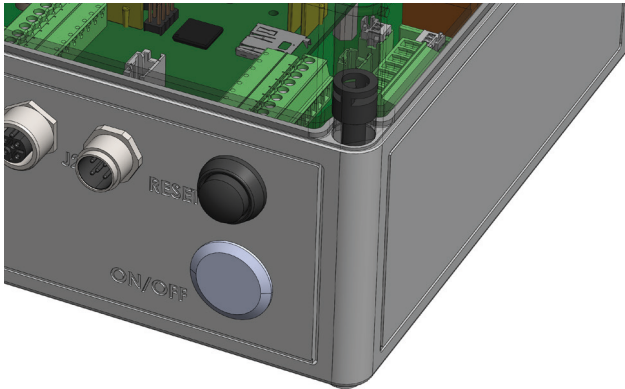

Figure 18. Power up the BIB

5.4. Status and control of the BIB

The state of the BIB can be controlled by the Be In Charge Software. The software can read and set the state of the BCI inside the BIB. The active state of the BCI is indicated by the highlighted button in the “BCI Control” section as depicted in Figure 18, and can be switched to a different state by selecting one of the other buttons.

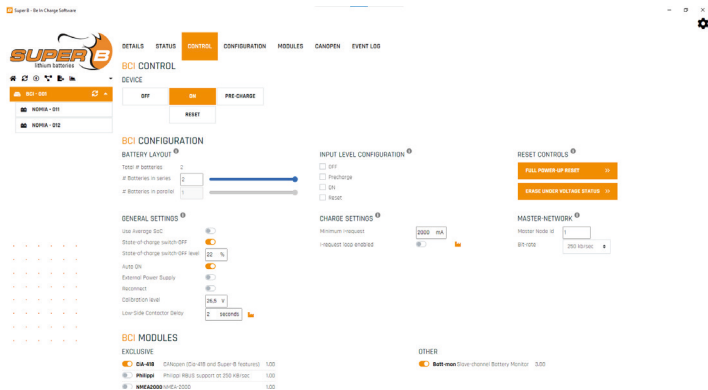

Figure 19. BCI control tab

The reset button can be used to reset the BIB when the BIB and or a Li-ion battery is in an

error state. More information about the different states and the corresponding behaviours can be found in chapter 3.2.

5.5. Status of the battery bank

The status of the battery bank can be seen in the 'BCI status' section of the Be In Charge Software (see Figure 19), in the 'Bank State' subsection. The information shown in the image is subject to change depending on the Be In Charge software version.

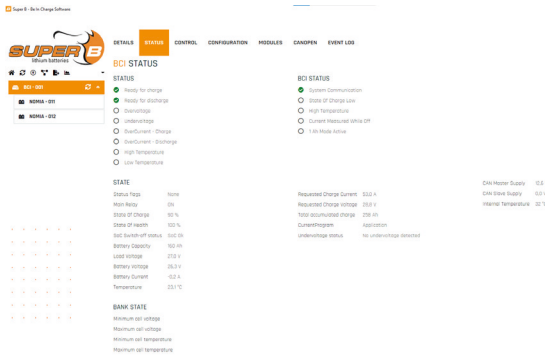

Figure 20. Status of the battery bank

6. Inspection and cleaning

6.1. General information

Disconnect the BIB from all loads and Li-ion batteries before performing cleaning and maintenance activities (see paragraph 4.7).

6.2. Inspection

Inspect for loose and/or damaged wiring and contacts, cracks, deformations or damage of any other kind. If damage to the BIB is found, it must be replaced. Do not attempt to use a damaged BIB.

6.3. Cleaning

If necessary, clean the BIB with a soft, dry cloth. Never use liquids, solvents, or abrasives to clean the BIB.

6.4. Replacing the Coin Cell Battery (For BCI HW V1.7 and above)

The CR1216 coin cell will last approximately 3 years when no power is applied to the BIB across that entire time frame. With external power applied to the BIB, the battery capacity should last >5 years.

In applications where there are frequent power interruptions to the BIB, it is recommended to change the coin cell every 3 years if the RTC functionality is required.

In applications where power loss to the BIB is negligible, it is recommended to change the coin cell every 5 years if the RTC functionality is required.

6.4.1. Instructions for replacing the coin cell

Required tools:

- M3 Hex Key
- Screwdriver Flat 5mm

1. Safely power down the application and switch off the BIB.
2. Remove the lid from the BIB via the 4 screws. Disconnect the battery bank from the BIB.
3. Disconnect the CAN cables connected to the Master and/or slave ports on the BIB.
4. Using the M3 hex key, remove the 2 screws that fix the BCI board to the stand offs, and disconnect the 2 green connectors as shown in Figure 21

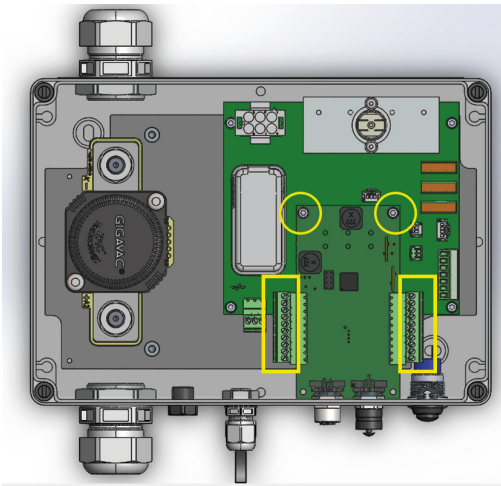

Figure 21. M3 Hex Screws and Connectors to disconnect

5. To remove the BCI board from the BIB, slide the BCI PCB carefully out of the CAN connector housings in the direction shown in Figure 22.

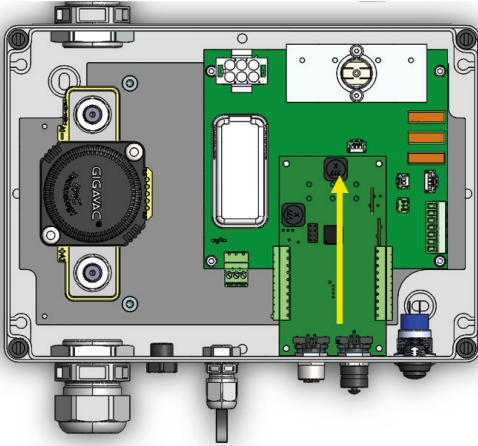

Figure 22. Slide the BCI PCB carefully out of the CAN connector housing.

6. On the underside of the BCI the coin cell can be found, shown in Figure 23.

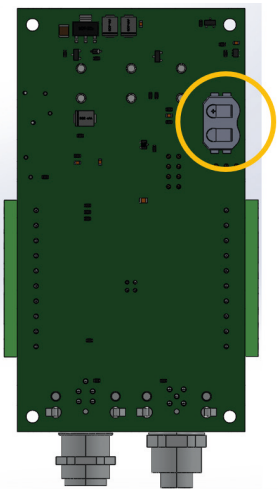



Figure 23. Coin Cell Location

7. Ensure there is no signs of leakage from the old cell. If there is, carefully use contact cleaner to remove the corrosion in the area.
8. Replace the cell with a new high quality 30mAh CR1216 cell.
9. Slide the BCI back into place in the CAN connector housings and fasten with the 2 hex screws. Ensure that the 2 connectors are plugged back in securely.
10. Reassemble the BIB and reconnect it back into the application.
11. To synchronize the time, connect the BIB with a CAN USB interface and open the BIC software. The date and time will be initially set to 01/01/1970 when the coin cell is replaced. Click the  icon next to the datetime entry to resynchronize the time on the BCI.

Datetime 01/01/1970 01:00:38 

7. Storage

Follow the storage instructions in this manual to optimize the lifespan of the BIB during storage. If these instructions are not followed and the BIB is not functioning anymore, consider it to be damaged. Do not attempt to use it. Replace it with a new BIB. See paragraph 3.4.3 for storage temperature conditions.

8. Troubleshooting

Problem	Possible reason	Solution
Green LED blinking with short off intervals	BIB scans for batteries	Wait 10 minutes after booting until the blinking stops.
Yellow LED blinking	BIB is in pre-charge mode	Configure BIB to ON-state.
	BIB has just booted and has not yet switched the relay	Typically the relay should be enabled within 5 seconds.
	The difference in voltage between battery bank and charger is too high to safely switch on the main relay.	Pre-charge circuit within the BIB is not capable of pre-charging the system. Turn off all loads before switching on the BIB. After the BIB is turned on, the loads can be enabled.

Yellow LED is on	One or more batteries are reporting an error.	Determine which battery is reporting the error. Check for excessive heat, any damage, short circuits, etc. Take appropriate safety precautions. If the problem has been resolved, reset the system (push button or through the Super B battery monitor application).
Red LED is on	The BIB cannot find one or multiple batteries.	Check the CAN cabling and terminators.
Red LED blinking. 1 flash in 1 second	Battery layout configuration incorrect	Doublecheck the battery layout. Does it match completely with the configuration as stored in the BIB?
	The BIB is not configured (first bootup)	Follow the steps in paragraph 5.2.

Table 12. Troubleshooting

9. Warranty and liability

No rights can be derived from this document. Any installation or use contrary to these instructions may void the warranty granted to you. Please refer to the sales agreement for warranty and other provisions applicable to your purchase. If the product is defective, please contact the dealer, reseller or retailer that you purchased the product from. Super B's liability for any of its products is limited to the corresponding provisions under mandatory applicable law.



For more information please contact:

Super B Lithium Power B.V.
Europalaan 202
7559 SC Hengelo (Ov)
The Netherlands

Tel: +31 (0)88 0076 000
E-mail: info@super-b.com
www: www.super-b.com

